

SR598ML3T



Mounting Pattern
Up to 800 x 600mm
(31.50" x 23.62")



Max Load
220lb
(99.8kg)



- Display height can be adjusted up to 25.6" (650mm) with the touch of a button
- Universal display adaptor fits mounting patterns from 300 x 200mm to 800 x 600mm
- Open frame display adaptor helps prevent display input interference
- Rear enclosure provides storage for mini PCs such as Shuttle, Dell OptiPlex Micro, HP 260 G2, Lenovo M600 Tiny or Intel NUC, and includes mounting locations for external WiFi antennas
- Corrugated cable pathways route and protect cabling during display movement and positioning
- Cord wrap included for managing surge protector cord
- Safety limit switch automatically reverses direction and stops when a collision is detected in an upward, downward or lateral force
- Includes Peerless-AV® PVP1200-CPL6 six outlet Power Strip with 15ft cord and 2160 joule rating (15A, 120V, 1800W, EMI/RFI noise filtering)
- Textured black powder coat finish helps hide finger prints and dust

SMARTMOUNT. Motorized Height Adjustable Tabletop Cart

FOR 55" TO 80" INTERACTIVE DISPLAYS

Peerless-AV's SmartMount® Motorized Height Adjustable Tabletop Cart was designed to get the most out of an interactive display. The motorized cart creates an ADA compliant solution by allowing a display to be raised to the appropriate height, based on the specific user, with just a touch of a button. A secondary actuator allows the tilt of the display to be adjusted from vertical to completely horizontal. This allows the interactive display to be used in a standard viewing position, drafting table position, or tabletop position. The rear compartment provides a secure area for a PC and power strip, while the cable management pathway protects the cables from snagging or abrasion when the display is raised or tilted. The cart's welded base and locking casters provide a stable foundation for touch applications, and the integrated power cord wrap makes moving the solution simple.



PRE-ASSEMBLED DESIGN

Simply attach the display and run the cabling

CABLE MANAGEMENT ACCESS

Easily route cabling from the inside compartment to the back of the display

VERTICAL ADJUSTMENT

Center of display is adjustable from 34"-60" (864-1524mm) from the floor

WELDED BASE AND PRE-ASSEMBLED CASTERS

Provides rigidity, stability and quick assembly

SAFE AND EASY MANEUVERABILITY

4" (102mm) swivel casters meet UL/CUL requirements



Move your display from a standard viewing position to a flat tabletop, or any angle in between, with the touch of a button.

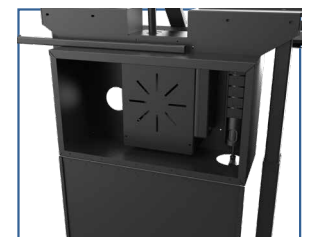

The rear enclosure includes a premounted surge protector and component mount to secure Mini PCs.



RoHS
2002/95/EC



Complies with the ADA Standards for Accessible Design, Section 308.

info@peerless-av.com
peerless-av.com

peerless-AV®
Driving Technology Through Innovation

SR598ML3T SmartMount® Motorized Height Adjustable Tabletop Cart for 55" to 80" Interactive Displays

Product Specifications

	DIMENSIONS (W X H X D)	PRODUCT WEIGHT	LOAD CAPACITY	FINISH	AVAILABLE COLORS
SR598ML3T	45.76" x 31.11"-68.97" x 28.88" (1162 x 790-1752 x 733mm)	139lb (63.0kg)	220lb (99.8kg) Display	Semi-Gloss Black Powder Coat	Black

Package Specifications

	PACKAGE SIZE (W x H x D)	PACKAGE SHIP WEIGHT	PACKAGE UPC CODE	PACKAGE CONTENTS	UNITS IN PACKAGE
SR598ML3T	47.25" x 13.50" x 37.75" (1200 x 343 x 959mm)	161.5lb (73.3kg)	735029327936	Assembled Base with Motorized Columns and Casters, Rear Enclosure, Universal Display Adaptor, Control Box, Control Switch, Surge Protector, Hardware & Instructions	1

Accessories

- ACC310: Feet Accessory
- ACC316: Safety Belt

All dimensions = inch (mm)

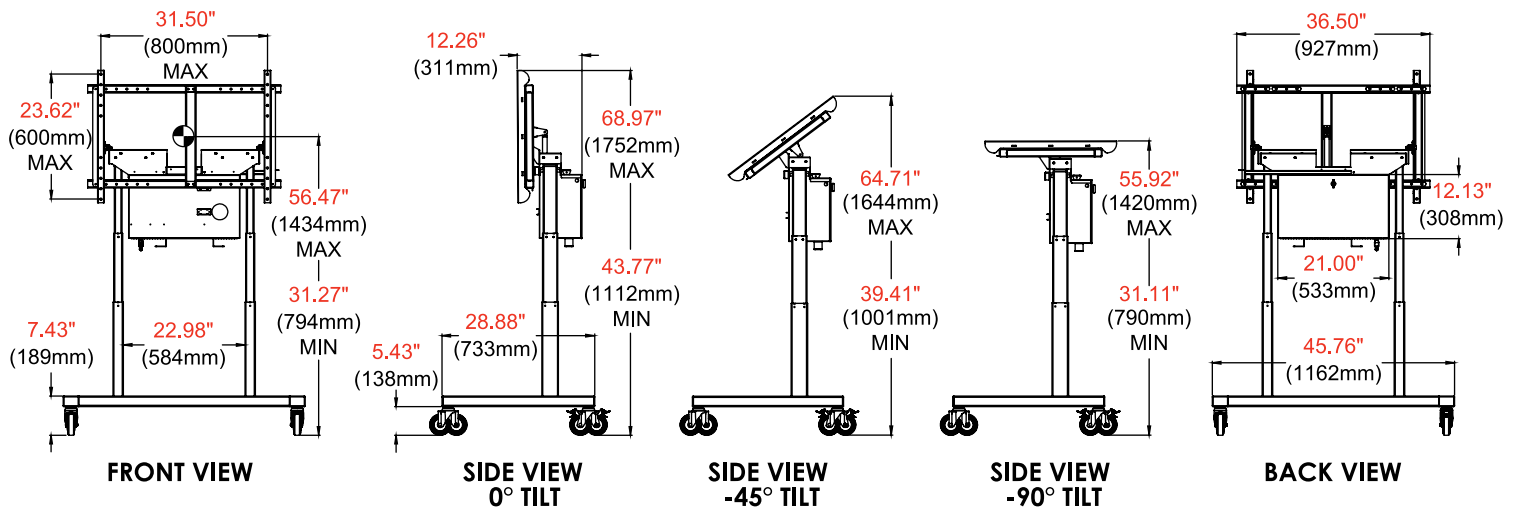

Architect Specifications

The SmartMount® Motorized Height Adjustable Tabletop Cart shall be a Peerless-AV model SR598ML3T and shall be located where indicated on the plans. Assembly and installation shall be done according to instructions provided by the manufacturer.

Visit peerless-av.com to see the complete line of AV solutions from Peerless-AV, including outdoor displays, kiosks, display mounts, projector mounts, carts/stands, and a full assortment of accessories.

Peerless-AV
2300 White Oak Circle
Aurora, IL 60502
USA
(800) 865-2112
(630) 375-5100

Peerless-AV EMEA
Unit 2 Curo Park
Frogmore, St. Albans
Hertfordshire, AL2 2DD
United Kingdom
+44 (0) 1923 200 100

Peerless-AV B.V.
Papendorpseweg 75
3528 BJ Utrecht
The Netherlands
+31 (0) 70 770 8037

Peerless-AV Latin America
Av. de las Industrias 413
Parque Industrial Escobedo
General Escobedo, N.L.,
México, 66062
+52 (81) 8384-8300

